

Express One 80"

INSTALLATION INSTRUCTIONS

For quick and easy installation of your folding door, read these instructions thoroughly. A few minutes of prior planning will make the job easier and will ensure years of trouble-free use.

Express One track must be installed into header of sound construction. Header and door jamb must be plumb and level for the track and door to install and function properly. Track cannot be installed into drywall or drop ceilings.

The Tools You Will Need

• #1 Phillips screwdriver • flathead screwdriver • tape measure • small nail • 3/32" drill bit for pilot holes • hacksaw or fine tooth saw (saw needed to trim top track for the appropriate width or to trim height of panels if door is less than 80" high) • masking tape (to secure doors if trimming is necessary) • Safety glasses • fine sandpaper (used to smooth edges after trimming).

Make Sure All The Following Parts Are Included With Your Folding Door:

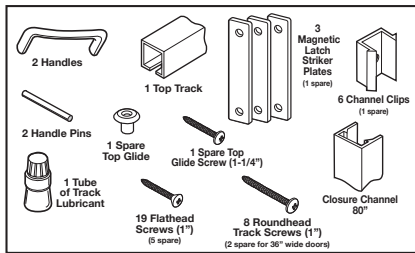

Door Parts Location

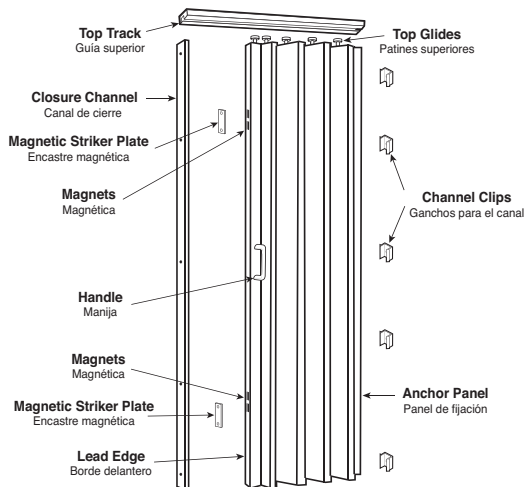

SINGLE DOOR INSTALLATION

1. Measure the Door Opening

If the height of your door opening is approximately 80", you will not need to alter the door itself. If the opening is less than 80" high, the door may be shortened by sawing off excess from the bottom of the door panels.

Stack the door panels together and secure with masking tape. Remove bottom hinge screws. Cut excess with a hacksaw or fine tooth saw. Reinsert hinge screws. Remove tape.

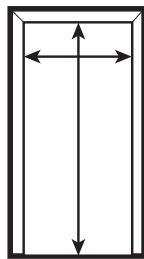

2. Install the Top Track

Cut the top track 1/8" shorter than the width of the opening. Position the top track on the top of the door opening so that it is straight and centered. You may not need to trim the top track.

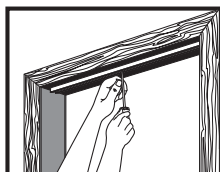

After making a pilot hole (with a nail or a 3/32" drill bit), drive a 1" track screw through the screw hole nearest the center of the track. Do not tighten. (Tape may be used to hold the track in place while you mark and drill.)

3. Install the Handles

Tap the two handle attachment pins into one handle, then fit the pins through the door panel holes. Press the other handle onto the pins.

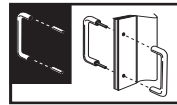

If necessary, you may back one handle with a solid object and tap the other handle alternately over each pin area until the handles are seated. Do not strike the middle of either handle.

4. Install the Door Panels

Apply track lubricant to each top glide. Swing one end of the top track out of the door opening to accept the top glides.

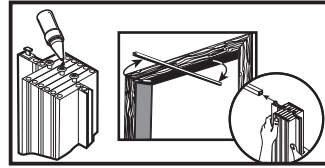

Decide if you need your door to open from the left or the right and slide all top glides onto the top track. When sliding the door onto the top track, make sure the panel with the door handles is facing towards the opening side. Stack the panels together near the center screw.

5. Secure the Top Track

Swing the track back to its original position. After making pilot holes (with a nail or a 3/32" drill bit), drive the 1" track screws through all track holes. Set all screws as straight and tight as possible to ensure smooth operation of the door. Be sure to fully tighten the first screw you installed in the track.



6. Secure the Anchor Panel

Use the closure channel to measure and align the channel clips. Align the channel on the non-opening side of the door jamb. Make sure the channel is plumb.

Mark each of the five closure channel screw holes and remove the closure channel. Make pilot holes (with a nail or a 3/32" drill bit) and install the channel clips loosely, using five of the 1" roundhead screws. Align the clips vertically and fully secure the screws. Press the door anchor panel onto them until it snaps into place.

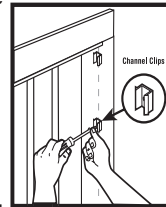

7. Secure the Closure Channel

Align the closure channel on the opening side of the door jamb. Make sure the channel is plumb.

Mark each of the five screw holes (as above). If necessary, cut the channel to match the door size. Make pilot holes in door jamb (with a nail or a 3/32" drill bit) and install the closure channel, using five of the 1" flathead screws.

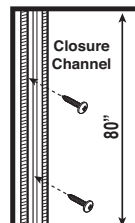

8. Install Magnetic Latch Striker Plates

Place a magnetic striker plate against one of the magnets on the lead edge. Pull the door until almost closed and mark the top and bottom location of the striker plate on the closure channel. Align the striker plate with the marked location and secure in the channel with two flathead screws. Repeat with the other striker plates.

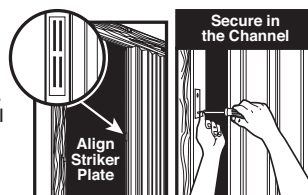

Double Door Installation

1. Measure the Door Opening

Divide the width of the opening by two. Cut each top track to this measurement so that when installed, the tracks butt against one another in the center of the door opening. It is also acceptable to use one track if it will fit your opening.

2. Install Top Track

On a center line drawn across the top of the door opening, install either half track and install all screws in the half track. If using a single track, use one center screw.

3. Install the Handles

Tap the two handle attachment pins into one handle, then fit the pins through the door panel holes. Press the other handle onto the pins.

If necessary, you may back one handle with a solid object and tap the other handle alternately over each pin area until the handles are seated. Do not strike the middle of either handle. Repeat with other handle.

4. Install the Door Panels

Apply track lubricant to each top glide. Install the two doors in the half track with lead edges facing each other. If necessary install the second track and push one door onto this track. Set a track screw at the track center joint and leave the screw projecting down 1/2" to prevent glides from passing the joint.

5. Secure the Anchor Panels

Use the closure channel to measure and align the channel clips. Align the channel on one of the door jambs. Make sure the top of the channel is plumb.

Mark each of the five closure channel screw holes and remove the closure channel. Make pilot holes (with a nail or a 3/32" drill bit) and install the channel clips loosely, using five of the 1" roundhead screws. Align the clips vertically and fully secure the screws. Press the door anchor panel onto them until it snaps into place. Repeat on the other door jamb.

6. Install the Closure Channel

Carefully remove the magnets from one lead edge using a putty knife or flat head screwdriver. Align the closure channel on the lead edge of one door so that it is flush with the top and bottom of the door. Mark each of the five screw holes on the lead edge and drill five pilot holes with a 3/32" bit. Install the closure channel using five 1" flathead screws.

7. Install Magnetic Striker Plates

Place a magnetic striker plate against one of the magnets on the lead edge. Pull the door until almost closed and mark the top and bottom location of the striker plate on the closure channel. Align the striker plate with the marked location and secure in the channel with the two flathead screws. Repeat with the other striker plates.



LTL HOME PRODUCTS, INC.

125 Rt. 61 • Schuylkill Haven, PA 17972
1-800-360-1585 • fax 570-385-5475

For more information:
Please email us or visit the Product Support section of our website
info@ltlhomeproducts.com
ltlhomeproducts.com